



ECRH on the Levitated Dipole Experiment

S. Mahar, J. Kesner, A.C. Boxer, J.E. Ellsworth, I. Karim, A. Roach
– *MIT PSFC*

A.K. Hansen, D.T. Garnier, M.E. Mauel, E.E. Ortiz
– *Columbia University*

*Presented at the 46th Meeting of the American Physical Society,
Division of Plasma Physics
Savannah, GA November 15, 2004*



Columbia University



Abstract

The use of multiple frequencies of electron cyclotron resonance heating (ECRH) in the Levitated Dipole Experiment is an important tool that will tailor the plasma profiles. The construction and details of the ECRH system will be discussed and initial experimental results will be presented. The effects of different combinations of pulse lengths and powers will be examined in terms of electron temperature profile and the plasma pressure profile. Future plans for different frequencies will also be discussed.

ECRH Basics

- Accelerate electrons with microwaves at the electron cyclotron frequency, Ω

$$\Omega = \frac{neB}{\gamma m_e}$$

- Will heat up electrons along lines of constant magnetic field amplitude
- Can shape pressure profile by using varying the power level in each frequency
- Calculate position of heating when magnetic field values are known

$$B(r) = \frac{\Omega \gamma m_e}{ne} = \frac{2\pi f \gamma m_e}{ne}$$

LDX Resonance Zones

- **B-field resonance:** $B(r) = \frac{2\pi f \gamma m_e}{ne}$
- **Current frequencies:**
 - 2.45 GHz (0-3 kW)
 - $B_{1st\ harmonic} = 0.0875T$ ◦ $B_{2nd\ harmonic} = 0.0438T$
 - 6.4 GHz (0-3 kW)
 - $B_{1st\ harmonic} = 0.229T$ ◦ $B_{2nd\ harmonic} = 0.114T$
- **In progress:**
 - 10.5 GHz (0-10 kW)
 - $B_{1st\ harmonic} = 0.375T$ ◦ $B_{2nd\ harmonic} = 0.188T$
- **Future:**
 - 18 GHz (0-10 kW)
 - $B_{1st\ harmonic} = 0.643T$ ◦ $B_{2nd\ harmonic} = 0.321T$
 - 28 GHz (0-10 kW)
 - $B_{1st\ harmonic} = 1.00T$ ◦ $B_{2nd\ harmonic} = 0.500T$

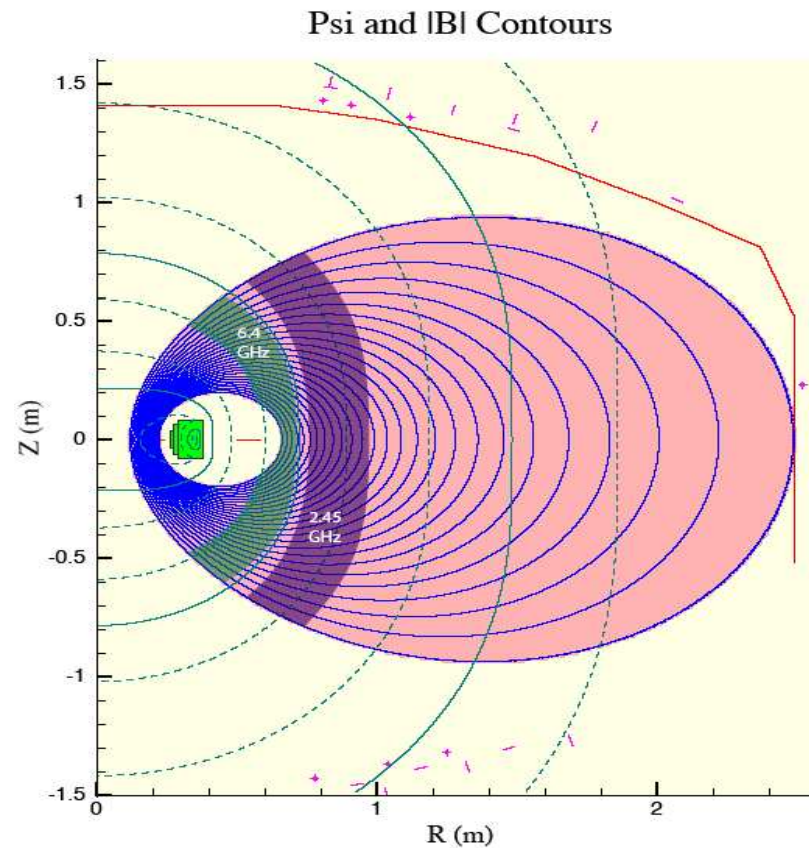

Note: Calculations for the first and second harmonics are done using a gamma of 1. However, Gammas of 1 up to 1.16 have been obtained in our September and August runs.

Positioning of Feedthroughs

- 2.45 GHz and 6.4 GHz use cavity heating
 - Microwaves are sprayed in through side port and reflect until absorbed
 - Launched extraordinary mode
- 10.5 GHz will use directional heating
 - Microwaves are launched from the bottom
 - Parallel to magnetic field in middle of dipole field

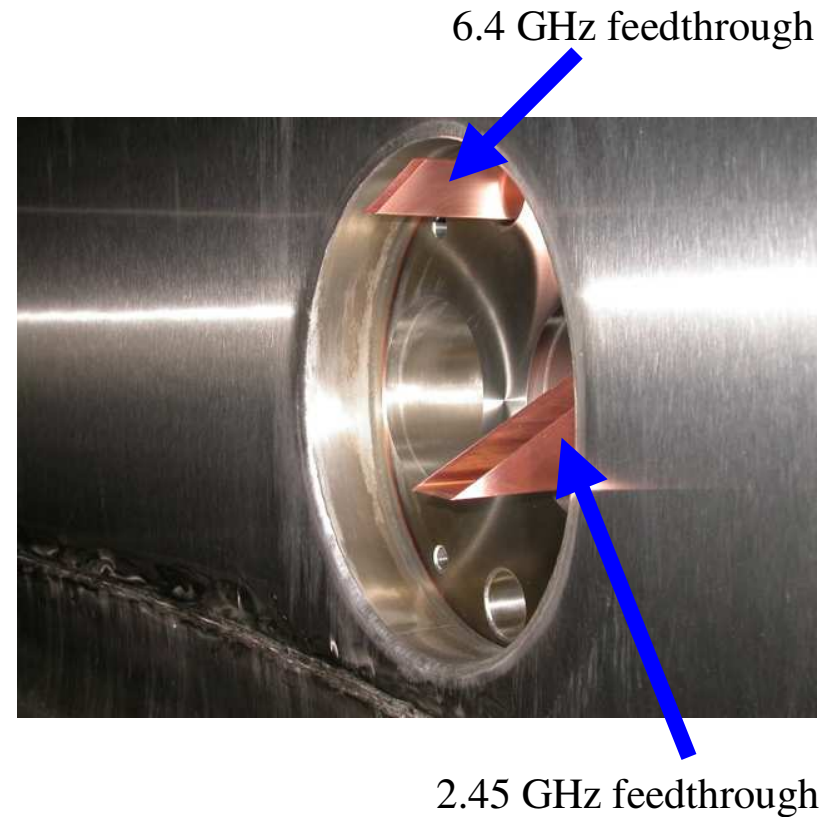

2.45 GHz System



- Magnetron generates microwaves
- The circulator protects the magnetron from reflected power
- The directional coupler detects forward and reflected power
- The expander expands WR284 waveguide to WR340
- The window separates the vacuum from the atmospheric air
- The conflat is where the feedthrough attaches to the vacuum vessel
- The feedthrough is the “antenna” inside the vacuum

2.45 GHz Magnetron



- A magnetron converts electrical energy to microwave radiation
- Electrons are emitted from a central cathode. The anode surrounding the cathode attracts the electrons. Instead of traveling in a straight line, permanent magnets force the electrons to take a circular path
- As they pass by resonating cavities, they generate a continuous pulsating magnetic field, or electromagnetic radiation
- Gerling Magnetron, Power of 0-3 kW

2.45 GHz Circulator

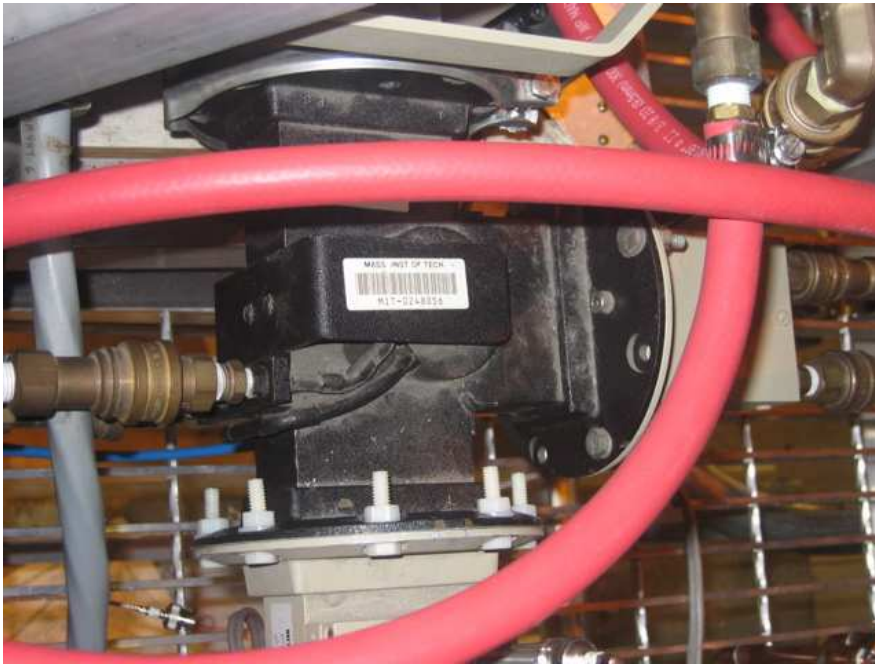

- Circulator is used to protect the magnetron from reflected power
- Circulator deflects the microwaves into a dummy load
- Because of the power and potential long pulses, system is be water-cooled

2.45 GHz Directional Coupler



- Directional Couplers are a diagnostic to determine the forward and reflected power
- Electric Field is detected in the waveguide
- Signal is passed through an attenuator and through a crystal diode
- 55.6 dB attenuation with Krytar crystal diodes

2.45 GHz Waveguide Run

- Mostly aluminum waveguide
- Magnetron side uses WR284
- Feedthrough side used WR340
- 12 inch expander section joins waveguide
- 20 feet of WR284
- Less than 6 feet of WR340
- 3, H-Plane Bends
- 1, E-Plane Bend
- 1, 2 foot bendable section
 - Bent 90 degrees
- 1, 45 degree twist section



2.45 GHz Window

- Window separates vessel side (vacuum pressure) from waveguide side (atmospheric pressure)
- WR340 size, which is why the expander was needed
- The window is a ceramic
- Capable of being water-cooled
 - Do not need this with only 3 kW of power

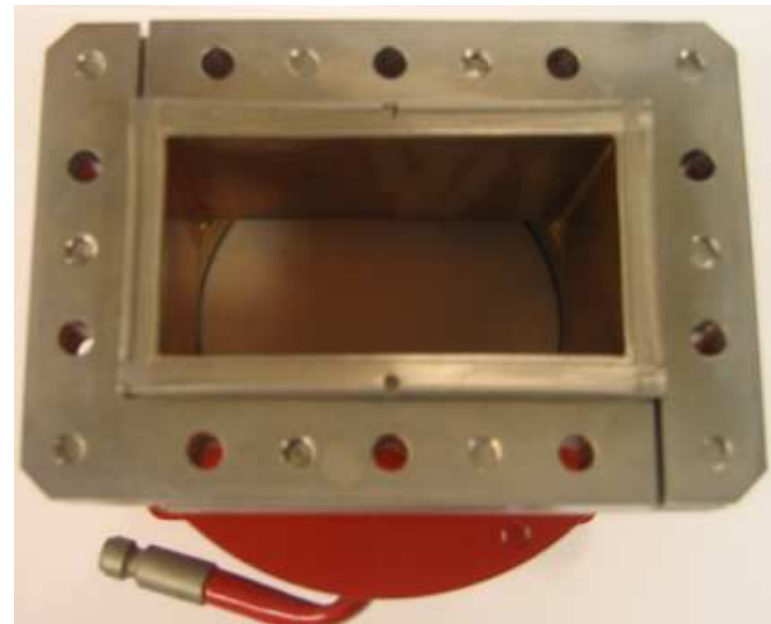
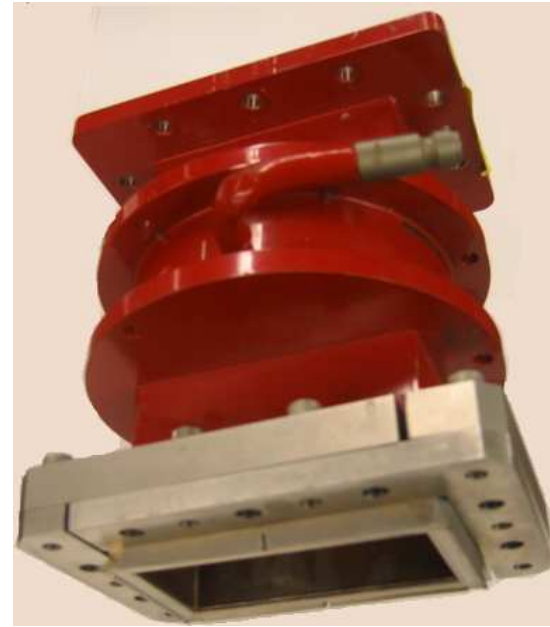

2.45 GHz Feedthrough

- Copper WR340 feedthrough silver-soldered onto stainless steel conflat
- Cut at 44.96 degrees to minimize reflected power
- Isotropically launches microwaves at midplane to cavity heat
- Extraordinary mode
- 7 inches long (vacuum side)
- Sticks out 1 inch past wall

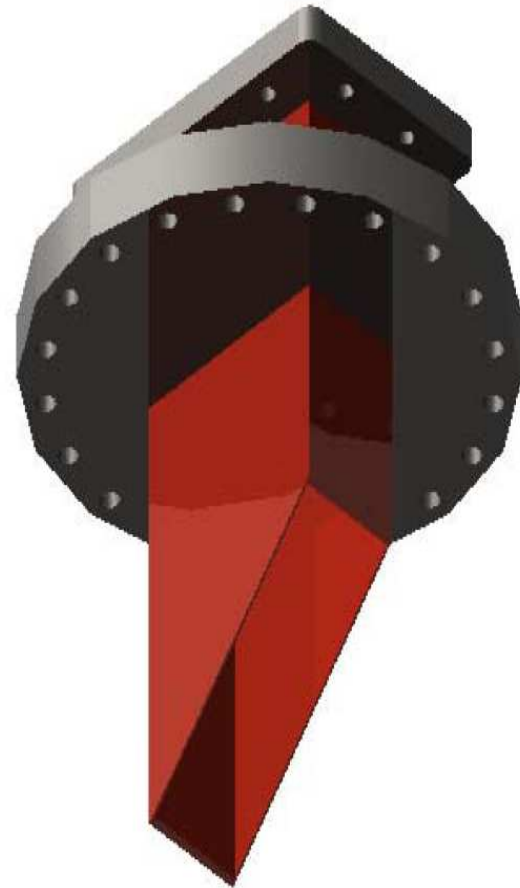

6.4 GHz System

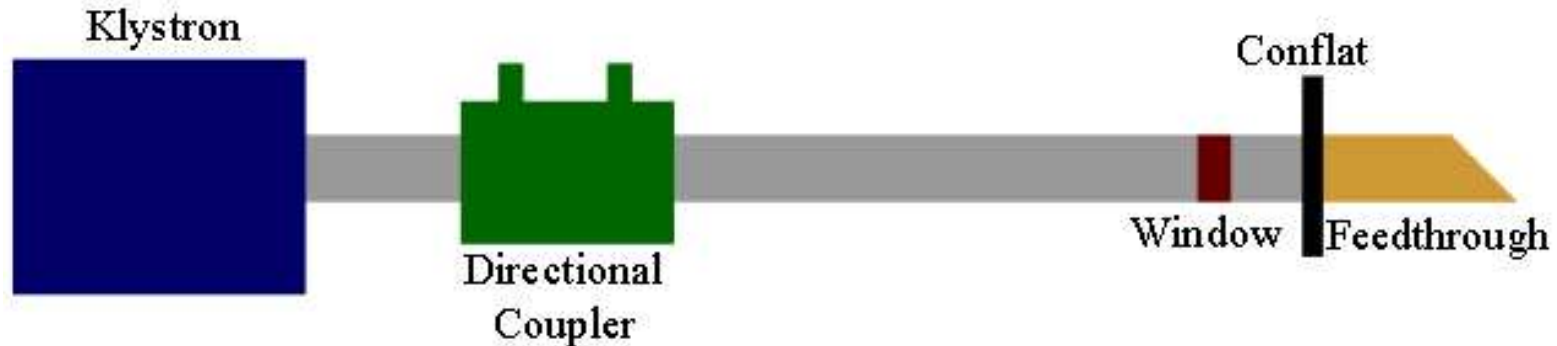

- Klystron generates microwaves
- The directional coupler detects forward and reflected power
- The window separates the vacuum from the atmospheric air
- The conflat is where the feedthrough attaches to the vacuum vessel
- The feedthrough is the “antenna” inside the vacuum

6.4 GHz Klystron



- A klystron converts electrical energy to microwave radiation
- An electron gun produces an intense flow of electrons into the klystron
- In the first cavity, a low-energy microwave signal intersects this continuous electron beam, breaking it up into a pulsed beam consisting of separate "bunches" of electrons
- These electrons pass through a tuned drift tube to a second cavity, where they are amplified and produce the microwaves that leave the chamber into the waveguide
- Our Klystron Specs:
 - Power of 0-3 kW
 - Beam voltage: 8.3 kV DC
 - Beam current: 1.08 Amps
 - Heater voltage: 6 V DC
 - Heater current: 6.8 Amps

6.4 GHz Directional Coupler

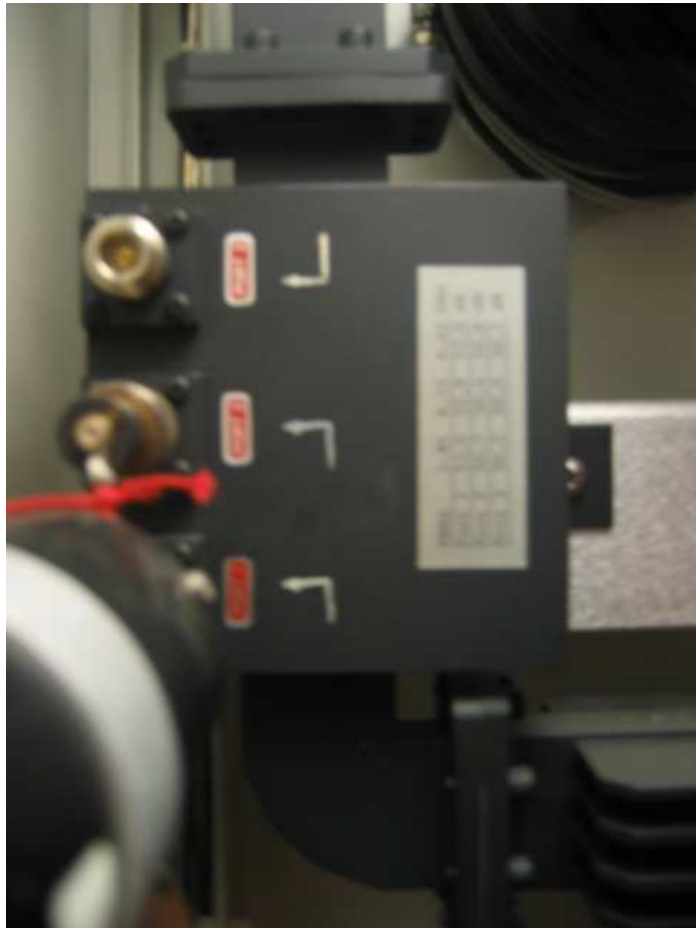

- Directional Couplers are a diagnostic to determine the forward and reflected power.
- Electric Field is detected in the waveguide
- Signal is passed through an attenuator and through a crystal diode
- Couplers are inside klystron cabinet
- 0-10 V Forward power output from central logic
- Reflected power is taken from internal coupler

6.4 GHz Window

- Window separates vessel side (vacuum pressure) from waveguide side (atmospheric pressure)
- The window is made of quartz



6.4 GHz Feedthrough

- Copper WR137 feedthrough silver-soldered onto stainless steel conflat
- Cut at 44.31 degrees to minimize reflected power
- Isotropically launches microwaves at midplane to cavity heat
- Extraordinary mode
- 8 inches long (vacuum side)
- Sticks out 2 inch past wall

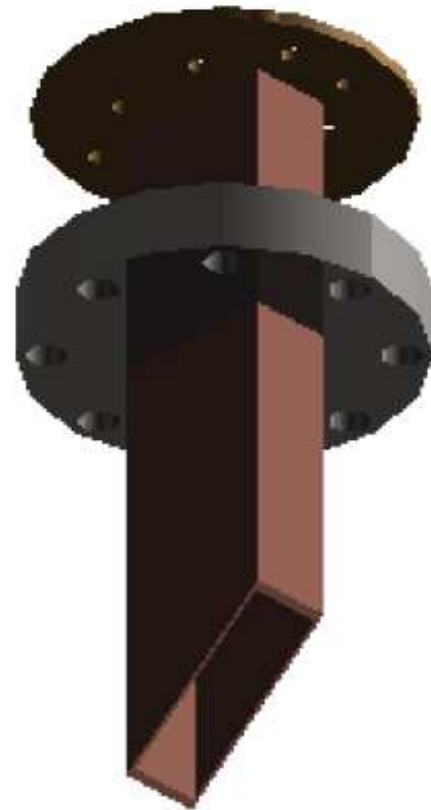

ECRH Triggering

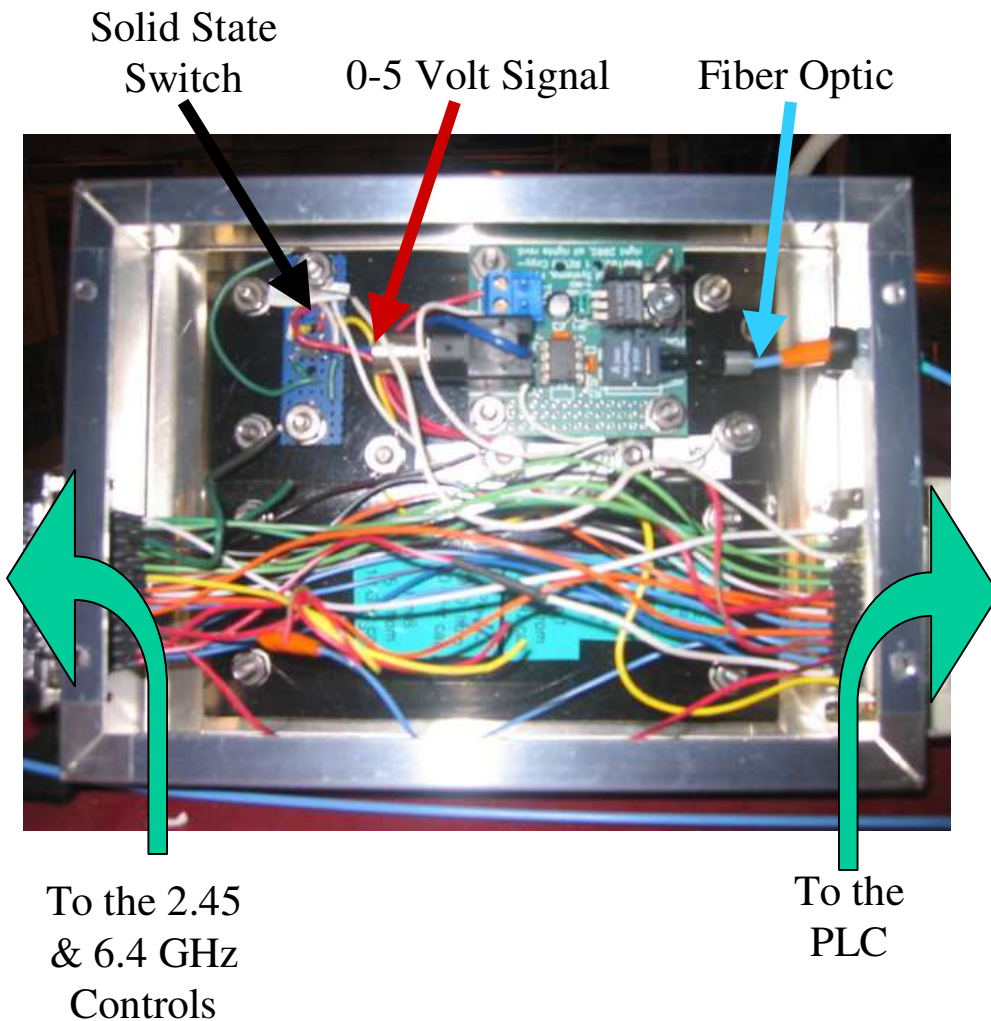

- Signal from timer module is changed to a fiber optic signal and run to the sources
 - Changed back into 0-5 V signal at source side
- 2.45 signal is input directly into the source
 - An inhibit switch is run through the Programmable Logic Controller, (PLC)
- 6.4 signal goes through a solid state switch, controlled by the PLC, to enable the source

ECRH Data

- Forward and reversed power are detected by the directional couplers
- 2.45 forward and reflected power comes directly from couplers
- 6.4 forward power is an output from cabinet
- 6.4 reflected power comes directly from coupler

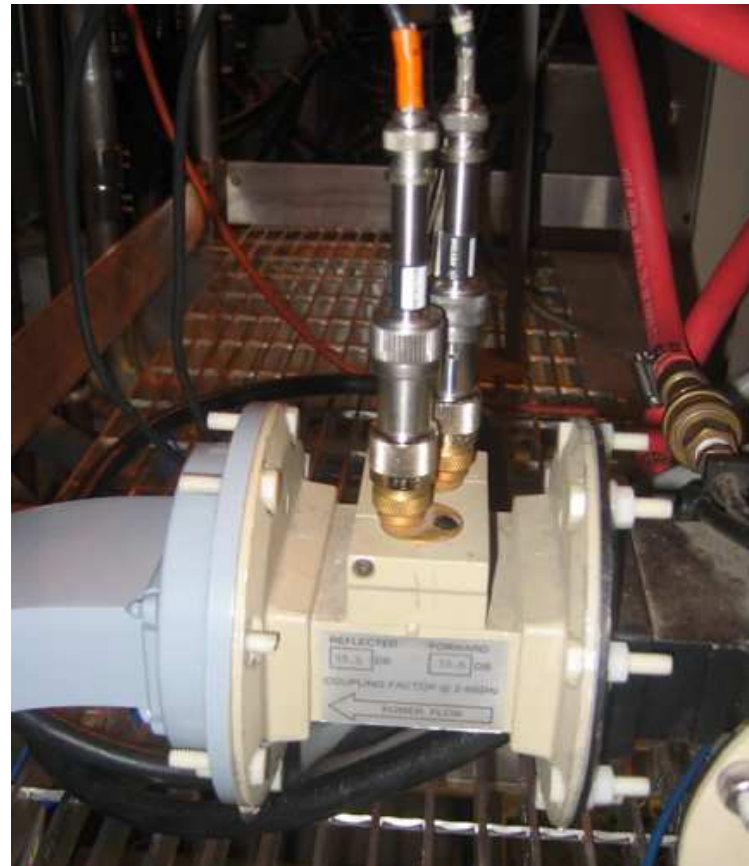

ECRH Data

- Signals run from couplers to digitizer cabinet in twisted pair cable
- Through a ribbon cable to the isolation amplification board
- 1:1 Inverting amplifier
- Through the digitizer and stored in the data tree
- Calibrations change voltages into power (kW)
- Shot 040917020

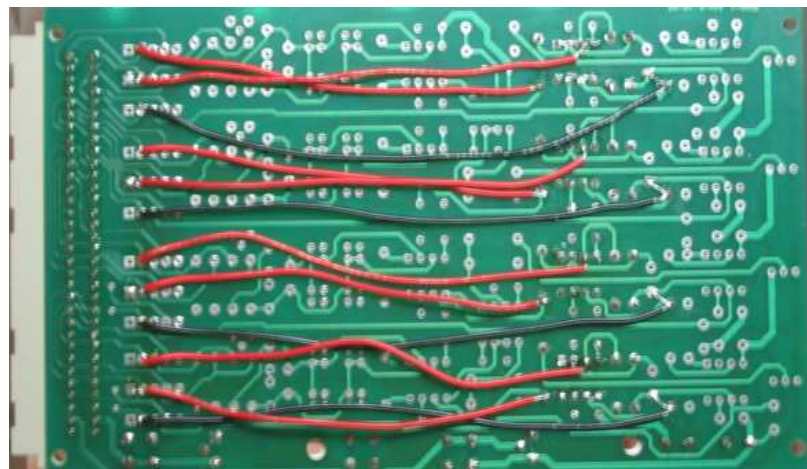
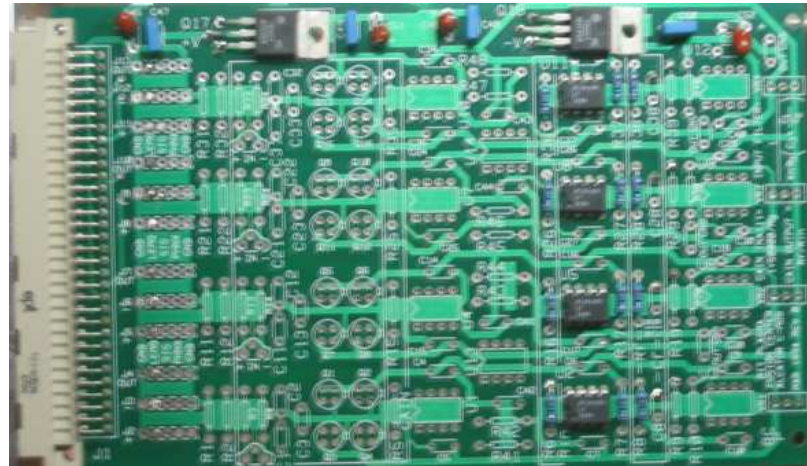

ECRH Data From 9-17-2004

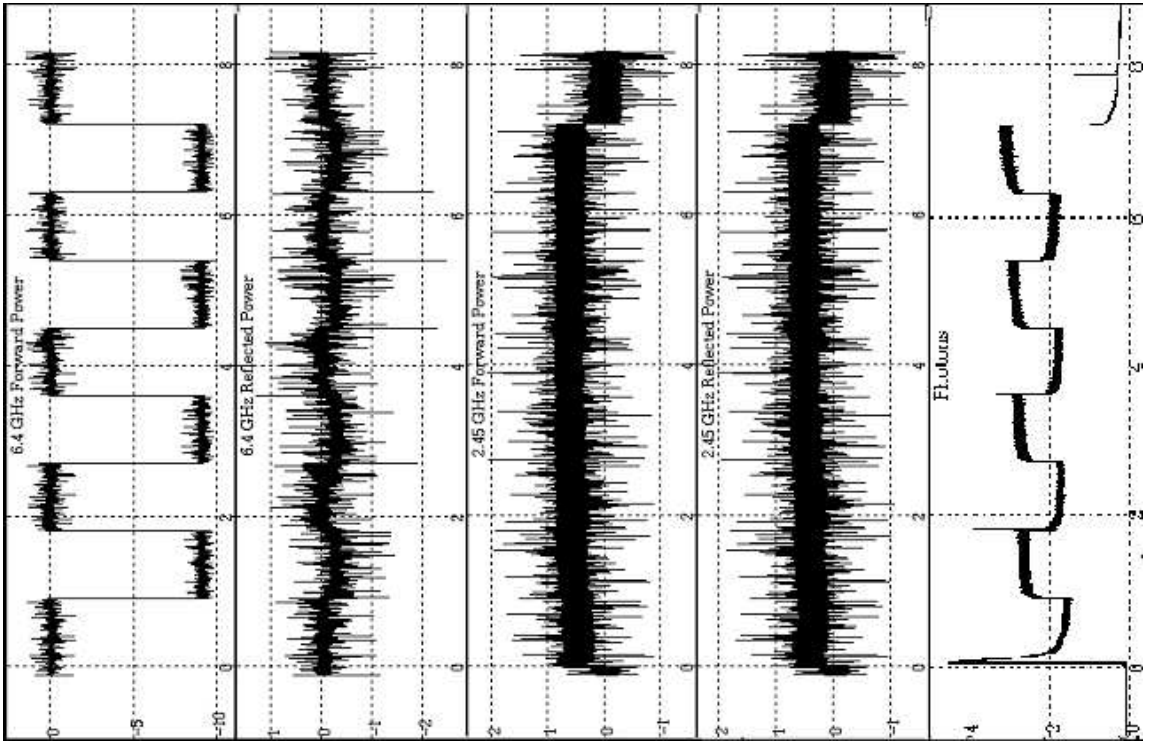

Shot: 20

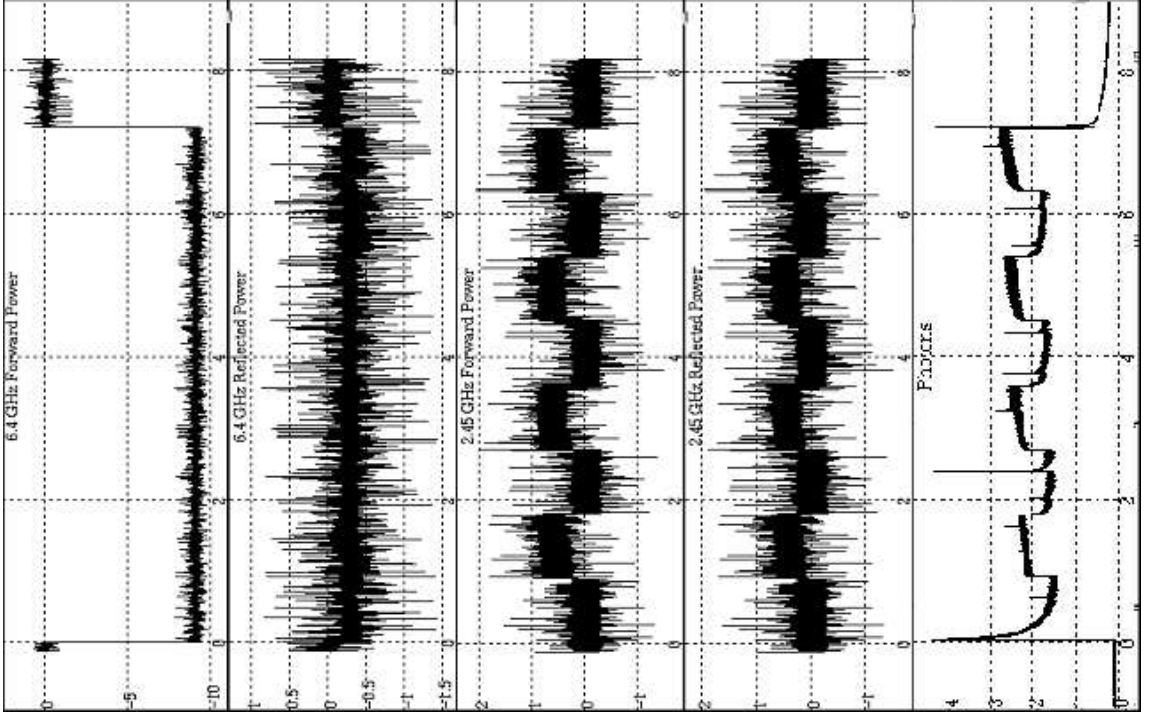

Shot: 19

Future Plans

- **Data**
 - Directional Couplers
 - Calibrate the directional couplers
 - Make the couplers more reliable
 - Plasma Radiation
 - Use filters at heating frequencies to detect what frequencies and powers the plasma radiates
- **10.5 GHz Source**
 - Waveguide run has been ordered
 - Water-cool the klystron
 - Finish electronic work in the cabinet
 - Set up detectors and data acquisition
- **18 and 28 GHz Sources Eventually**